

PLAN

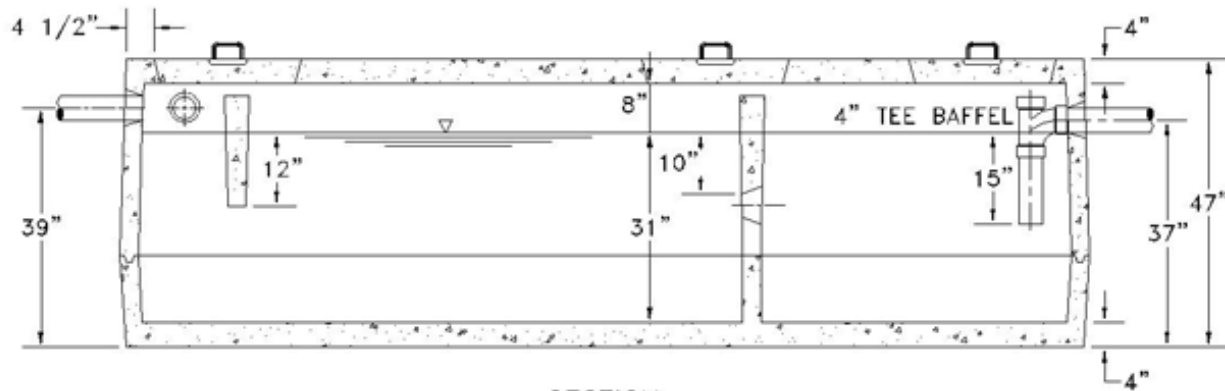

SECTION

1250 GALLON 2 COMPARTMENT SEPTIC TANK